

# ELEC 450 & ELEC 550, Introduction to Mobile Broadband

Doc. Mustafa Ergen  
Fall 2013  
Koc University

ELEC 450  
& ELEC 550  
Fall 2013

Location: ENG Z15

Hours: Friday 3.30pm-6pm

Office Hours: Friday 2pm





- **Instructor: Mustafa Ergen,**
  - email: [mergen@ku.edu.tr](mailto:mergen@ku.edu.tr),
  - Office Hours: 3pm or by appointment
- **Lectures:**
  - Friday, 3.30pm-6 pm,
  - Location ENG Z15
- **Recommended Textbook:**
  - Mobile Broadband – Including WiMAX and LTE
- **Class Homepage:**
  - TBD
  - All handouts, lecture notes, announcements, etc. posted to website
- **Class Mailing List: [elec450@ku.edu.tr](mailto:elec450@ku.edu.tr)**



# Course Information Policies

- **Grading:**
  - Project: Home Work - 30%, 1 Exam - 40%, Project - 30%



- The course will cover the upcoming mobile broadband technology and introduce basic building-blocks of today's communication and networking components.
- All-IP Networking brings tight interaction of wireless with IP communication. Hence, we'll see both sides of the story.



- Introduction to Mobile Broadband
  - 1G, 2G, 3G, 4G
  - Broadband Wireless
  - Market



- **Wireless Communication Basics**
  - Cellular Communication
  - Wireless Channel
  - Digital Communication
  - Rayleigh, Rician Channels
  - OFDM/OFDMA
  - Diversity
  - Duplexing



- All-IP Networking
  - IP
  - IP Routing
  - QoS
  - IP Security
  - AAA
  - EAP
  - Mobile IP
  - DHCP, NAT
  - SIP, IMS



- 3G and 4G Wireless Communication
  - WCDMA
  - OFDM
    - Coding
    - Synchronization
    - Channel Estimation
    - Equalization
    - PAPR





- Resource Allocation
  - Multiple Access
  - OFDMA
  - Frequency Reuse
  - Flash-OFDM



- **MIMO**
  - Spatial Diversity
  - MIMO Basics
  - SIMO/MISO/MIMO
  - Space Time Coding
  - BLAST
  - IEEE 802.11n



- UMTS
  - Networking
  - WCDMA
  - HSPA



- **WiMAX**
  - IEEE 802.16 OFDMA PHY/ IEEE 802.16m / IEEE 802.16j
    - Symbol
    - Frame
    - MIMO
    - Coding
    - Control
  - MAC
    - Header Suppression
    - ROHC
    - Sleep Mode
    - Handover
  - Network
    - Access Network
    - Reference Points
    - Accounting
    - Mobility
    - ROHC/MCBCS/LBS/ES/LI/USI/OTA



- LTE
  - EPS
  - E-UTRAN
  - LTE Networking
  - LTE MAC
  - LTE PHY
  - SC-FDMA
  
- UMB



- Femtocell
  - Architecture
  - Interference Management
  - RRM
  - Handover



- Cognitive Radio
  - IEEE 802.22
  - White Space Coalition
  - Networking
  - Detection



KOÇ  
UNIVERSITY

# Syllabus 12/12

- Self Organizing Networks
- Software Defined Networking



## Before Mobile Broadband

Paving the way towards 4G

## Very Very Early- Concept



Pre-Cellular Concept

First Mobile Telephone Radio  
1924



Cellular Concept

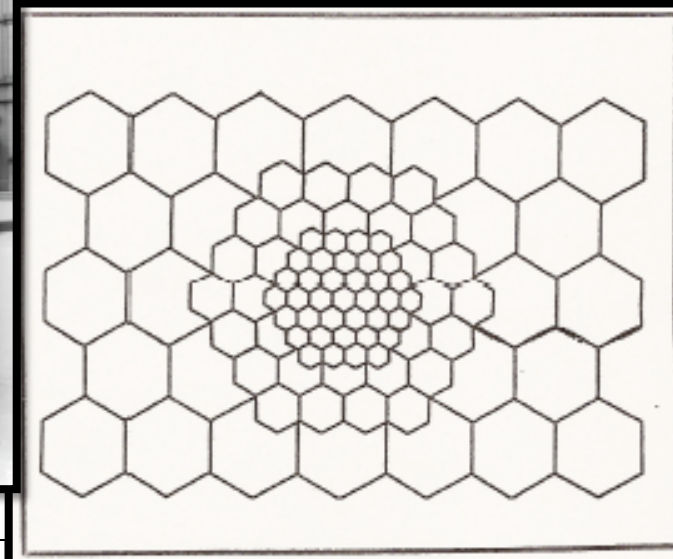

One very highly-elevated antenna in a very large service area

One channel

Very very low bit rate !!!!

One highly-elevated antenna in a large Service area

Small number of channel

Very low capacity

Frequency Reuse

Multiple Access

Proposed by Bell Laboratories in 1947



## FCC Chairman Powell statement

- We are still living under a spectrum "management" regime that is 90 years old. It needs a hard look, and in my opinion, a new direction.
- Historically, I believe there have been four core assumptions underlying spectrum policy:
  - Unregulated radio interference will lead to chaos;
  - Spectrum is scarce
  - Government command and control of the scarce spectrum resource is the only way chaos can be avoided
  - The public interest centers on government choosing the highest and best use of the spectrum.



## Powell's statement (cont.)

- Today's environment has strained these assumptions to the breaking point.
- Modern technology has fundamentally changed the nature and extent of spectrum use. So the real question is, how do we fundamentally alter our spectrum policy to adapt to this reality?
- The good news is that while the proliferation of technology strains the old paradigm, it is also technology that will ultimately free spectrum from its former shackles.

# What is our resource? Wireless Spectrum

**•It is all about spectrum!!!**

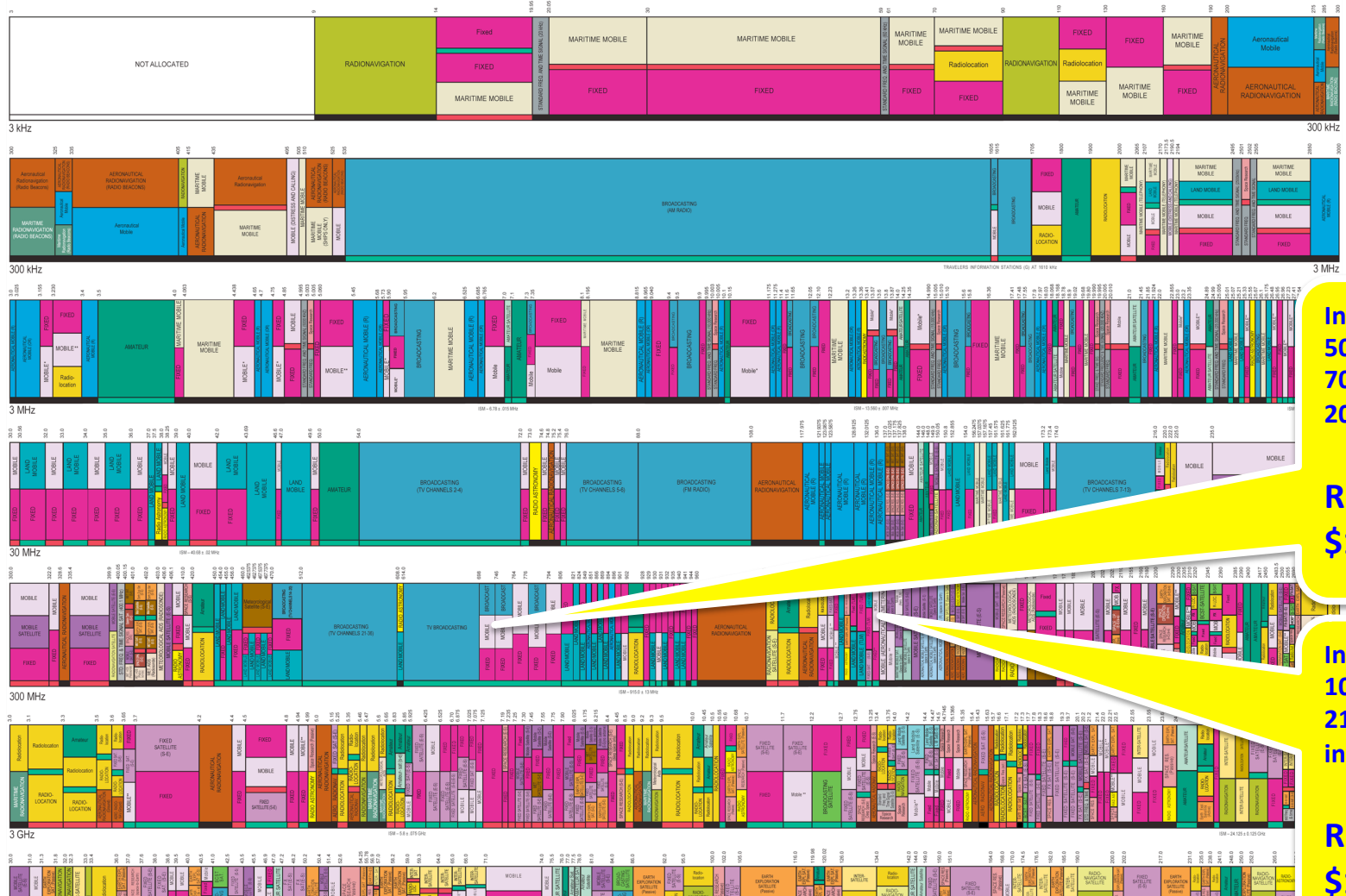

**In USA  
50MHz at  
700MHz in  
2008**

**Raised  
\$19B**

**In TR, 3G  
105MHz at  
2100MHz  
in 2008**

**Raised  
\$1.3B**

# How we can achieve Multiple Access?

- By creating orthogonal resources

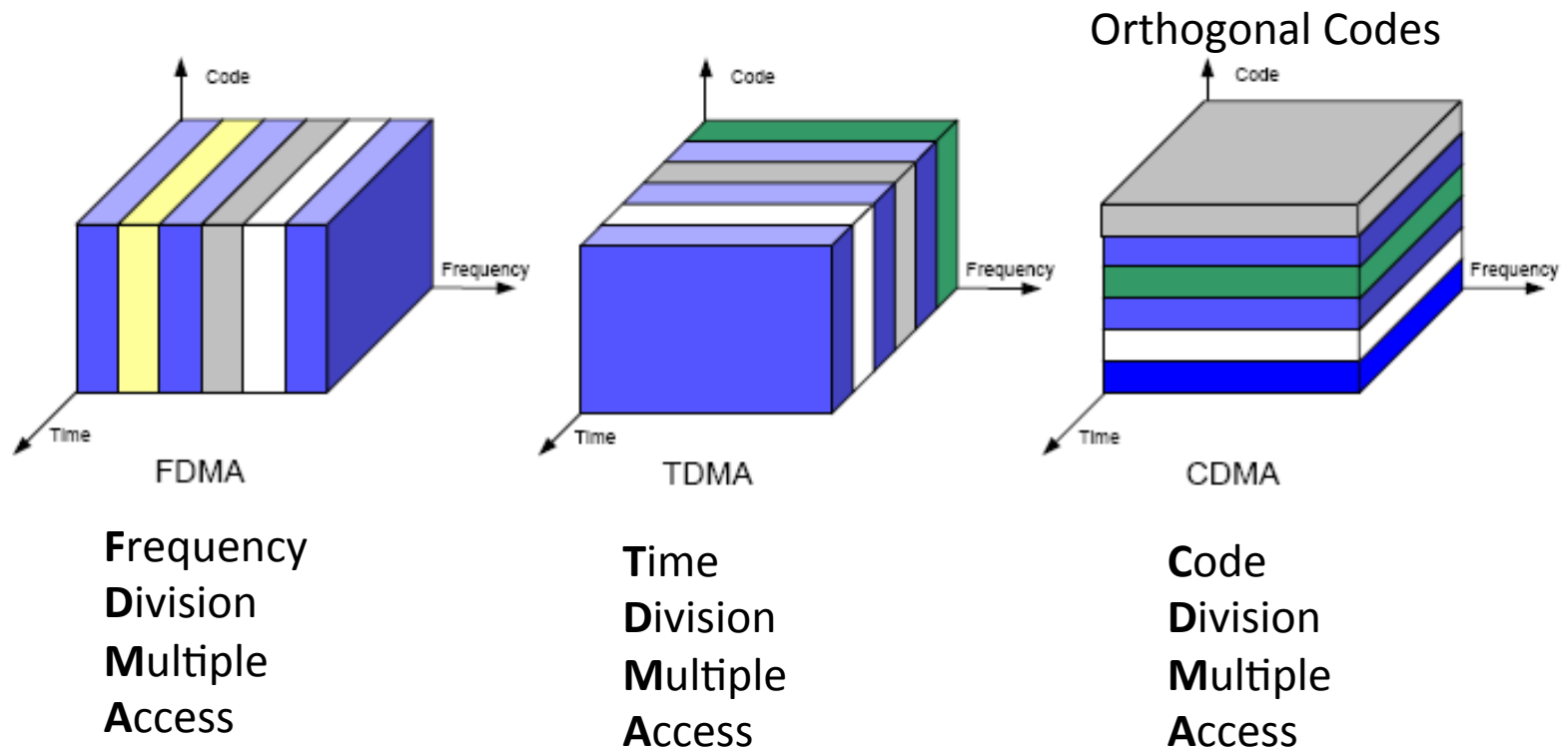



# When it is started?

- 1G- Analog Voice
- AMPS - FDMA
  - Invented 1946
  - Deployed in 1980s
  - 30KHz FM
  - Lack of standardization

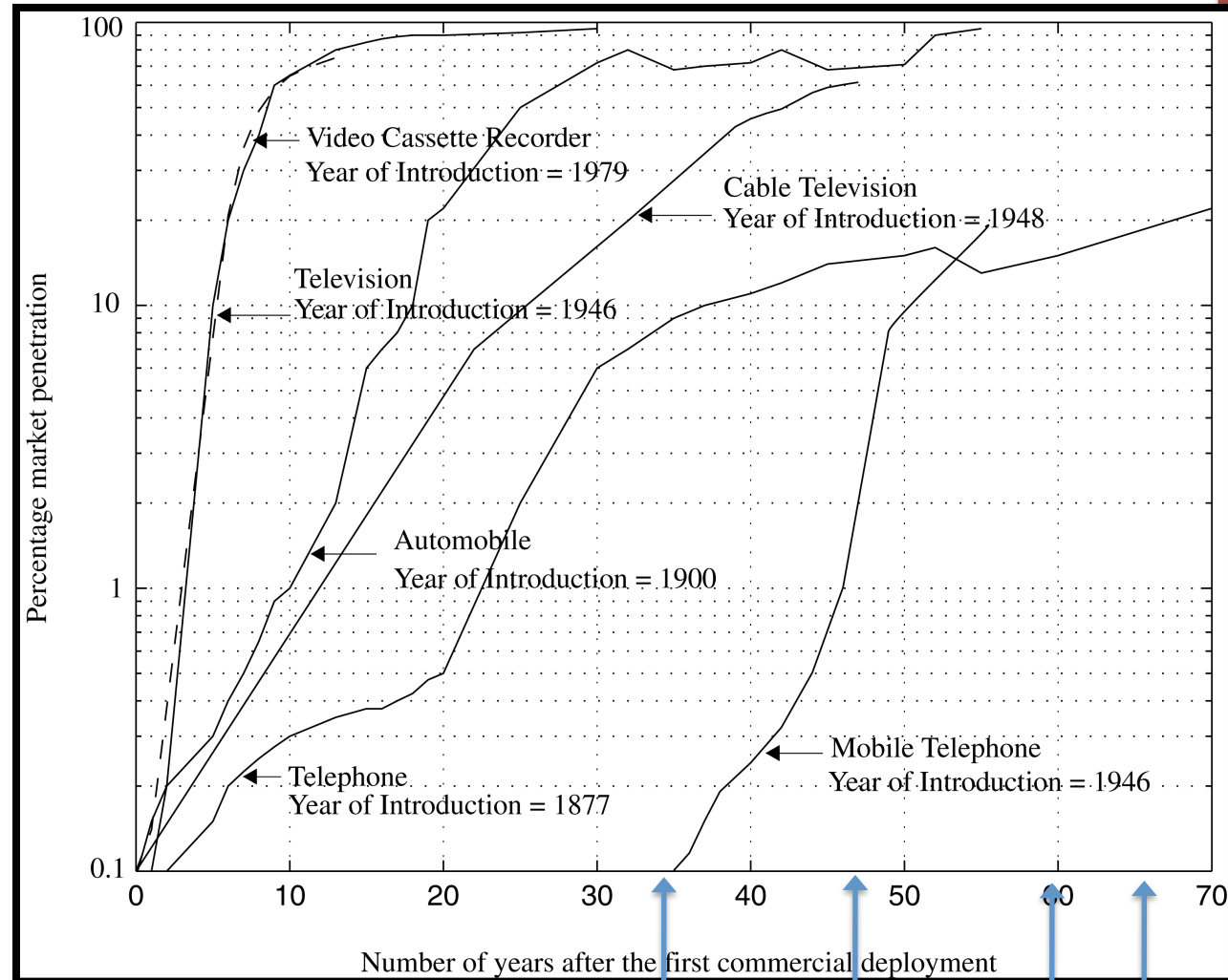

1G

2G

3G

4G

# When “people” start using it?

- 2G- digital voice
- GSM in Europe – TDMA
- IS-95 in US - CDMA
- Frequency allocation problem – no roaming

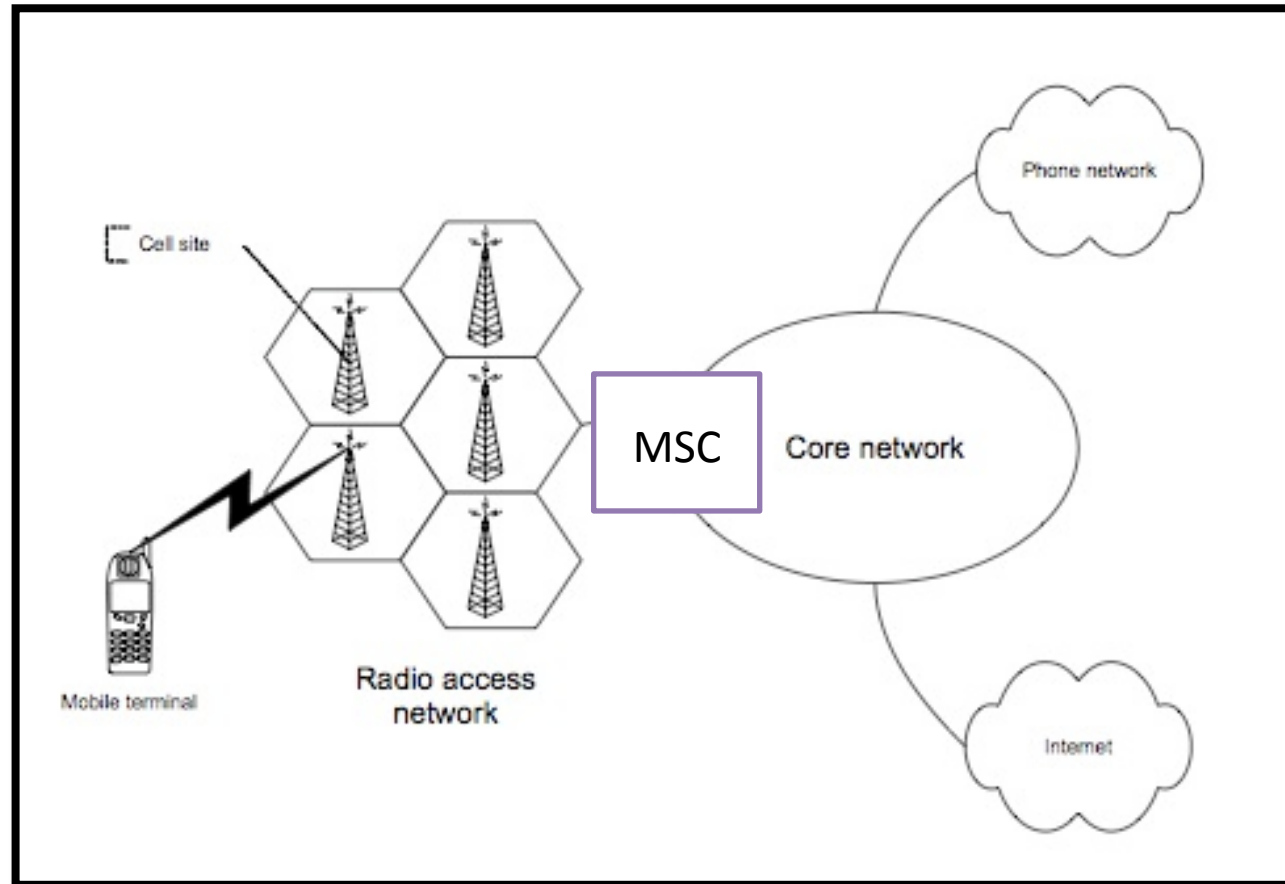



# What is an Orthogonal Code? In CDMA

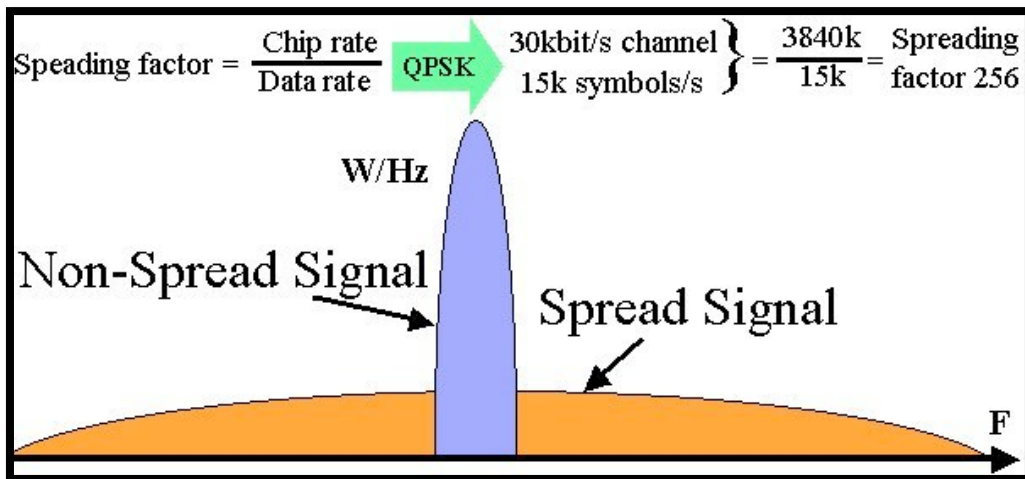
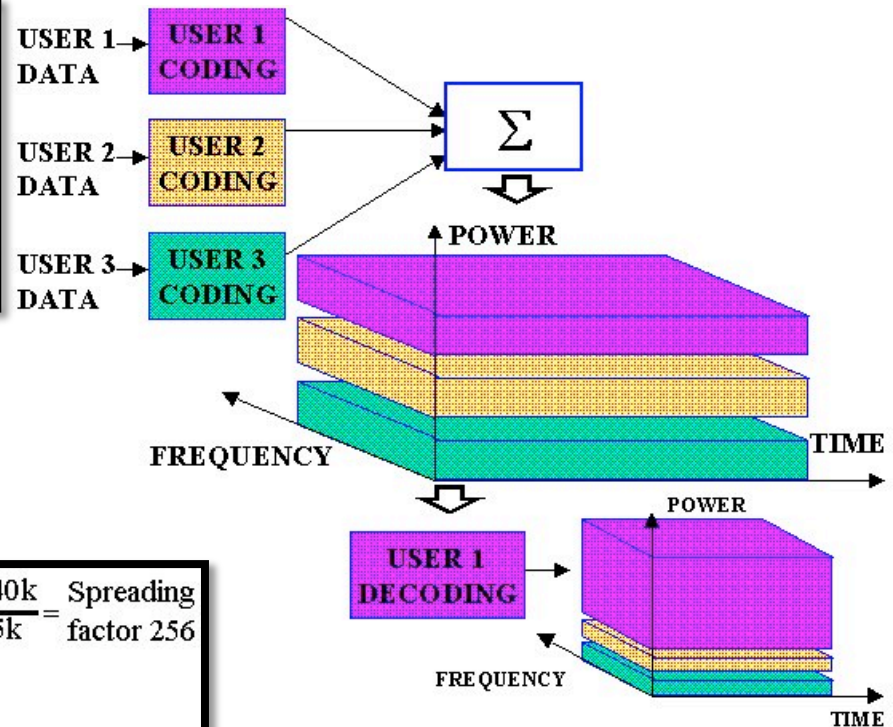
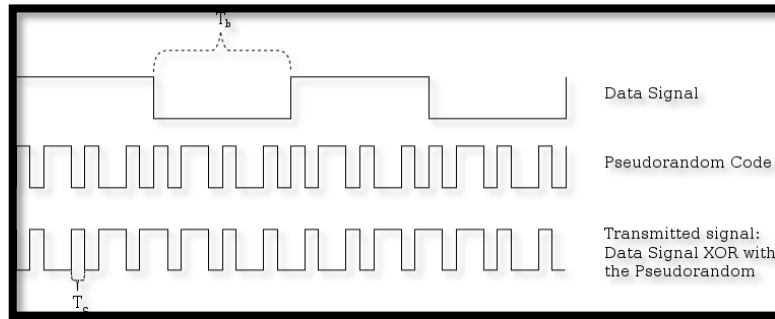



- 2G – Packet-based data services
  - GSM
    - GPRS
      - Peak data rates up to 140Kbps
    - EDGE
      - Peak data rates up to 384Kbps
  - IS-95
    - IS-95A
      - Up to 14.4Kbps circuit switched data
    - IS-95B
      - Up to 64Kbps packet-switched data

**Table 1.1** Major Mobile Radio Standards in North America

Standard	Type	Year of Introduction	Multiple Access	Frequency Band	Modulation	Channel Bandwidth
<b>AMPS</b>	Cellular	1983	FDMA	824-894 MHz	FM	30 kHz
<b>NAMPS</b>	Cellular	1992	FDMA	824-894 MHz	FM	10 kHz
<b>USDC</b>	Cellular	1991	TDMA	824-894 MHz	$\pi/4$ -DQPSK	30 kHz
<b>CDPD</b>	Cellular	1993	FH/ Packet	824-894 MHz	GMSK	30 kHz
<b>IS-95</b>	Cellular/ PCS	1993	CDMA	824-894 MHz 1.8-2.0 GHz	QPSK/ BPSK	1.25 MHz
<b>GSC</b>	Paging	1970s	Simplex	Several	FSK	12.5 kHz
<b>POCSAG</b>	Paging	1970s	Simplex	Several	FSK	12.5 kHz
<b>FLEX</b>	Paging	1993	Simplex	Several	4-FSK	15 kHz
<b>DCS-1900 (GSM)</b>	PCS	1994	TDMA	1.85-1.99 GHz	GMSK	200 kHz
<b>PACS</b>	Cordless/ PCS	1994	TDMA/ FDMA	1.85-1.99 GHz	$\pi/4$ - DQPSK	300 kHz
<b>MIRS</b>	SMR/PCS	1994	TDMA	Several	16-QAM	25 kHz
<b>iDen</b>	SMR/PCS	1995	TDMA	Several	16-QAM	25 kHz



# Adoption before 3G?

- Market Penetration %80
- Total num of subs: > 3B
- Deployed in 212 countries and territories

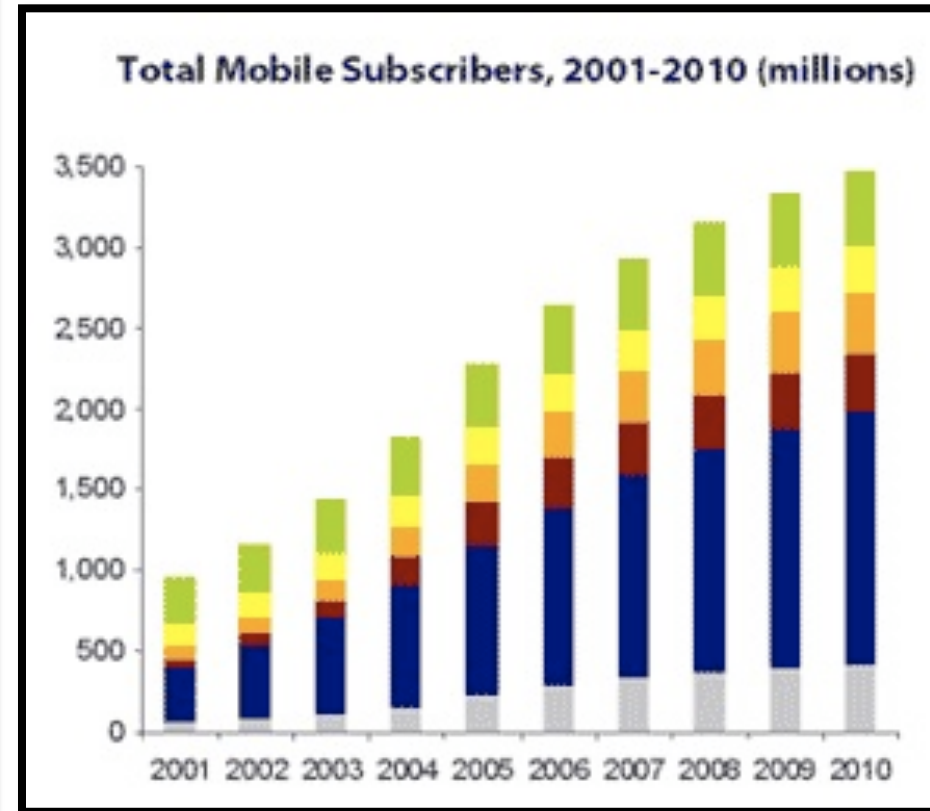
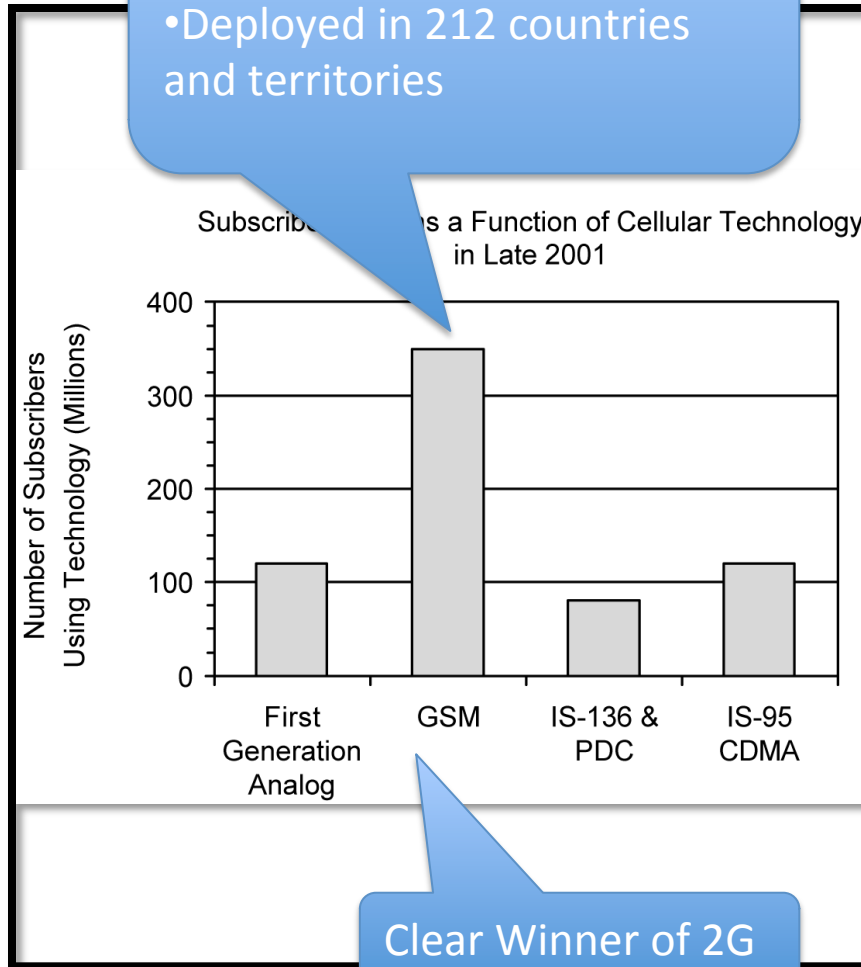

# How it is adopted? Network Externality

- the value of a product or service increases as more people use it.

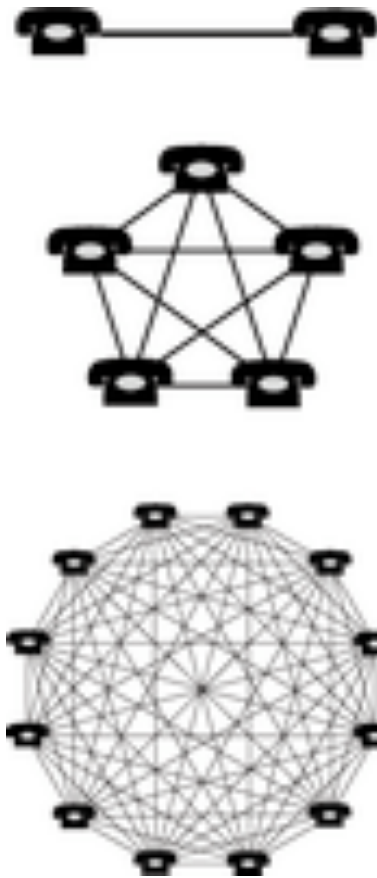

Bandwagon effect:  
People starts believing it is useful merely because many other people do so

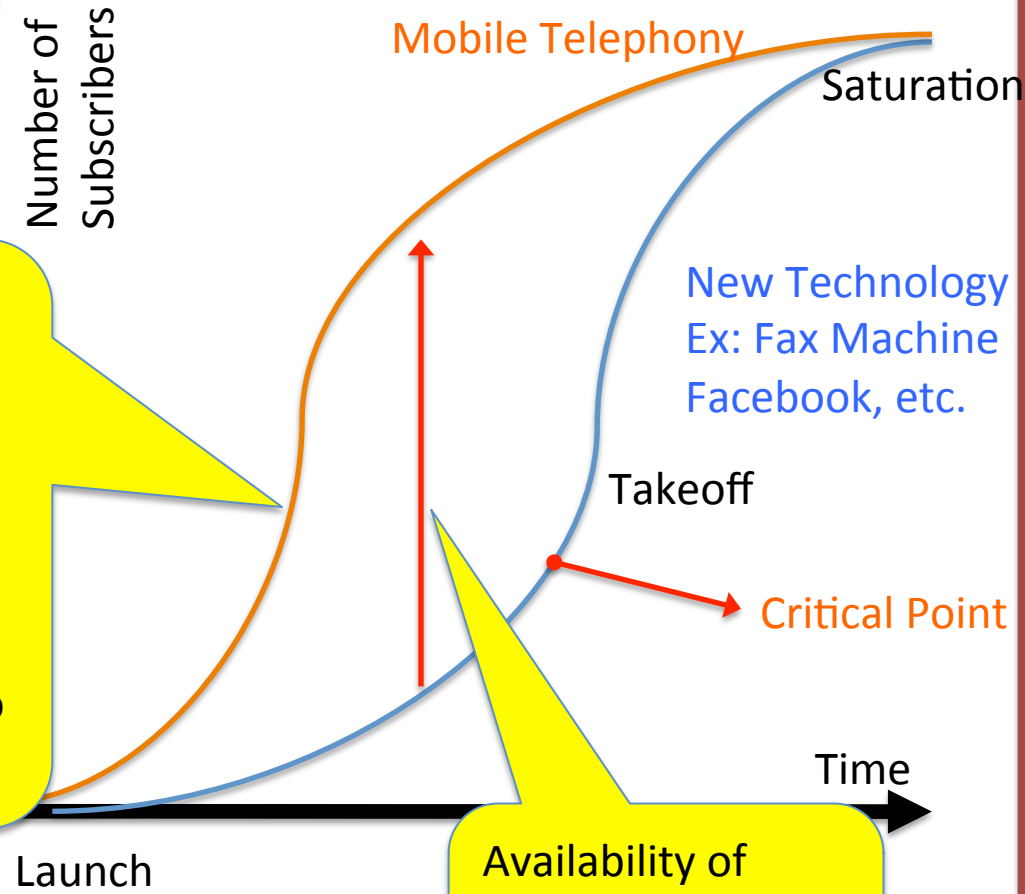

Availability of fixed telephony accelerated the adoption.



- Started with DSL – Digital Subscribers Line
  - Utilizes twisted pair copper wire of the local loop of the public switched telephone network (PSTN)
    - Plain Old Telephone Service (POTS)
      - Utilizes 300 and 3.4KHz for voice communication
    - DSL
      - Utilizes beyond 3.4KHz
      - The length and quality of loop determines the upper limit
      - Utilizes Discrete Multitone Modulation
        - » OFDM: Orthogonal Frequency Division Multiplexing



# DSL Architecture

## Broadband Remote Access Server

- Aggregates the output from DSLAMs
- Provides user PPP sessions over IP or ATM sessions
- Enforces quality of service (QoS) policies
- Routes traffic into an Internet service provider's backbone network

## Digital Subscriber Line Access Multiplexer

a device for DSL service. Sending on the customer or downstream side, it intermixes voice traffic and data traffic on the customer's DSL line. Receiving on that side, it accepts and separates outgoing phone and data signals from the customer. It directs the data signals upstream to the appropriate carrier's network, and the phone signals to the voice switch.

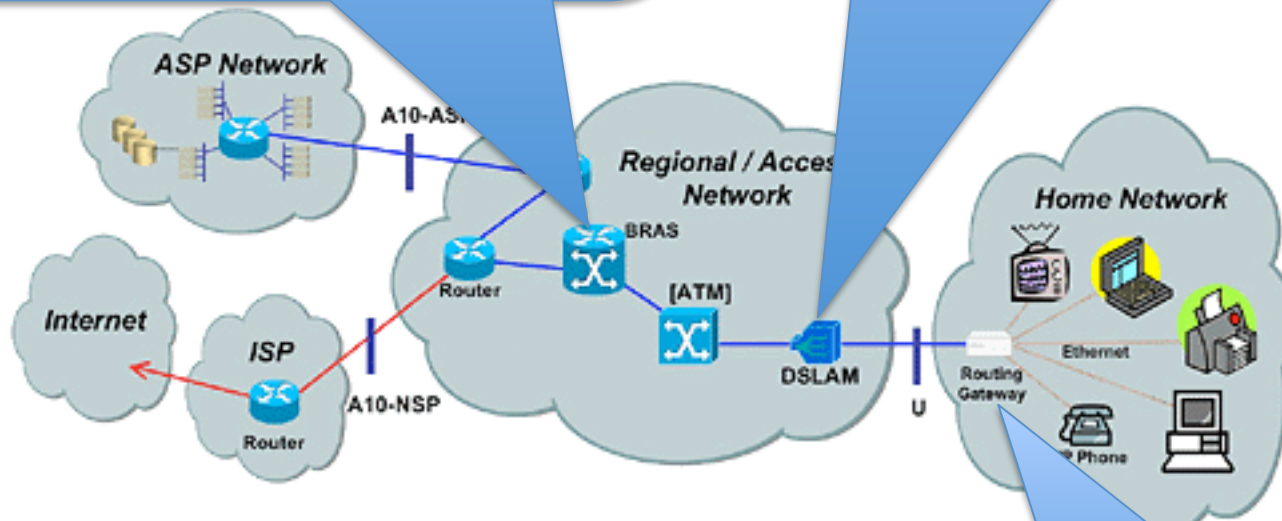

DSL Modem



- Driven by DSL Forum – [www.dslforum.com](http://www.dslforum.com)
  - Several xDSL standards
    - ADSL
    - SHDSL
    - VDSL
    - ADSL2plus
    - VDSL2
    - and more
- Holding 60% of the broadband subscribers  
350M worldwide at the end of 2007  
ADSL can deliver 8Mbps over about 2km  
ADSL2plus can go up to 24Mbps

First it is used for Internet Connection, Now, data, voice, video and especially for IPTV





Acquisition servers (A-servers) perform live content acquisition from various local and terrestrial sources for linear broadcast TV

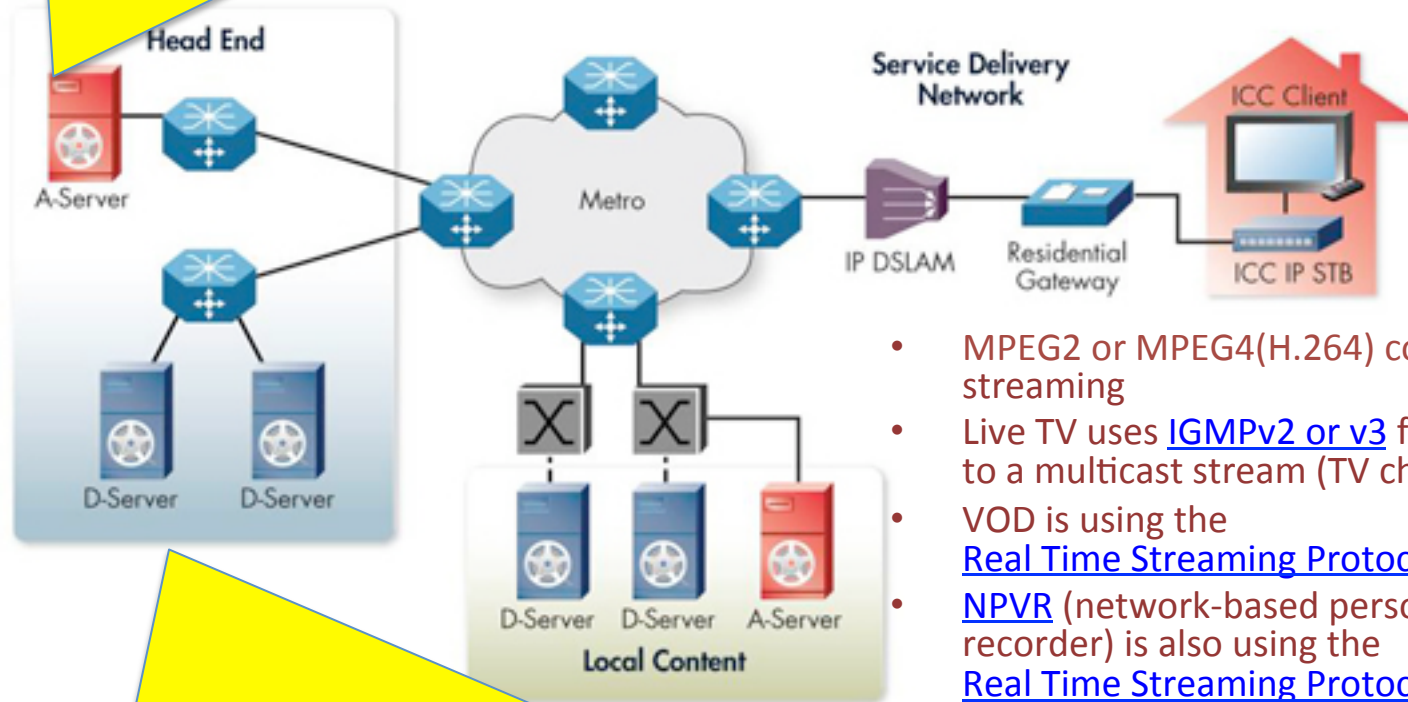

- MPEG2 or MPEG4(H.264) codec for streaming
- Live TV uses [IGMPv2 or v3](#) for connecting to a multicast stream (TV channel)
- VOD is using the [Real Time Streaming Protocol](#) (RTSP).
- [NPVR](#) (network-based personal video recorder) is also using the [Real Time Streaming Protocol](#) (RTSP).

Distribution servers (D-servers) are used to distribute frequently used content from various points of presence in the provider's network for faster access and to minimize channel switching time.



- Deliver high-speed data transfer over an existing coaxial Cable TV (CATV)
- Driven by Cable-Labs, founded in 1988
- Defines DOCSIS – Data Over Cable Service Interface Specification
  - Services include
    - Multimedia services
    - IP telephony
    - Multimedia conferencing
    - Interactive gaming
    - General multimedia applications
    - VoD Metadata and HDTV

- Besides copper wire or coaxial cable for “last mile” delivery, there is also **fiber**

- FTTH- fiber-to-the-home over an optical fiber
- FTTN, fiber-to-the-node
- FTTC, fiber-to-the-curb
- FTTB, fiber-to-the-building
- FTTP, fiber-to-the-premises

**Data rate > 1Gbps**

## Active or Passive Networks

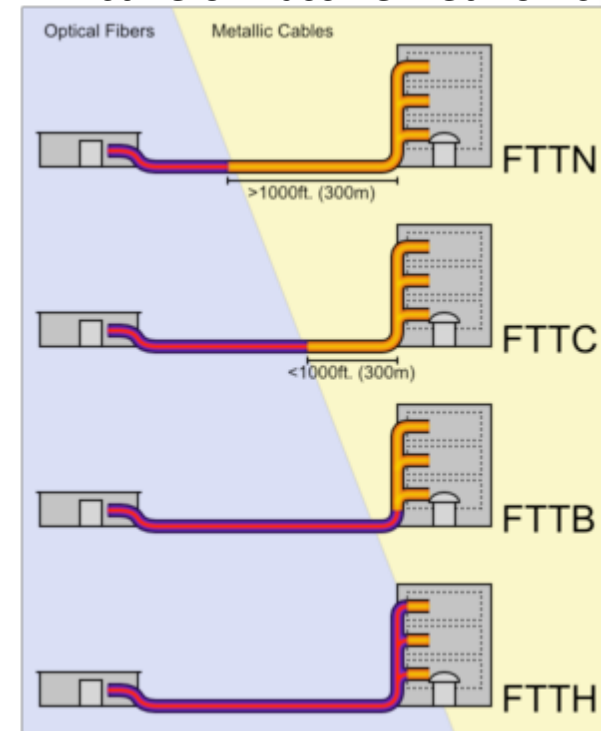

## BROADBAND SUBSCRIBERS BY TECHNOLOGY (MILLION)

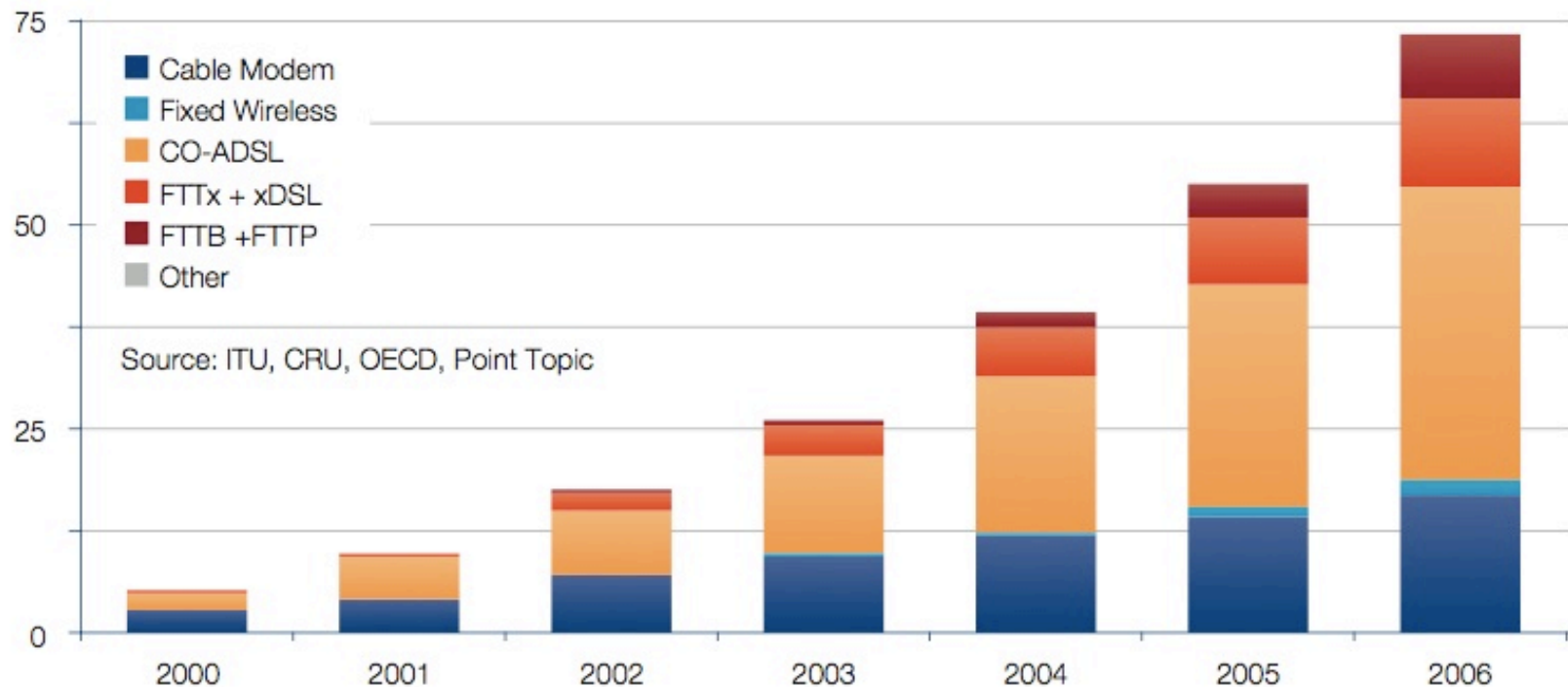



- **Wireless Local Area Networking**
  - Debut of IEEE with IEEE 801.11 and WiFi Alliance
  - Operates in unlicensed frequency
  - Single frequency network, multiplexing is CSMA
    - ISM bands – Industrial, Scientific, and Medical bands
      - 900Mhz, 2.4Ghz, and 5.8Ghz
    - U-NII band – Unlicensed National Information Infrastructure band
      - 5GHz
    - WLAN is secondary user in ISM, primary in U-NII

# What is **CSMA**?

## Carrier Sense Multiple Access

CSMA-CD (Collision Detection) is utilized in Ethernet

CSMA-CA (Collision Avoidance) is utilized in Wireless LAN

### CSMA/CA

- Step1: Listen the channel
- Step2: Transmit if channel is idle
- Step3: If channel is busy, wait until transmission stops plus a contention period, which a random period to ensure fairness. A node decrements the backoff counter if it detects the channel idle for a fixed amount of time.
- Step4: Node transmits when back-off counter is zero.
- Step5: If the transmission is unsuccessful, no ACK, contention window is selected from a random interval, which is twice the previous random interval. The process is repeated until it gets a free channel.



# Hidden Node Problem

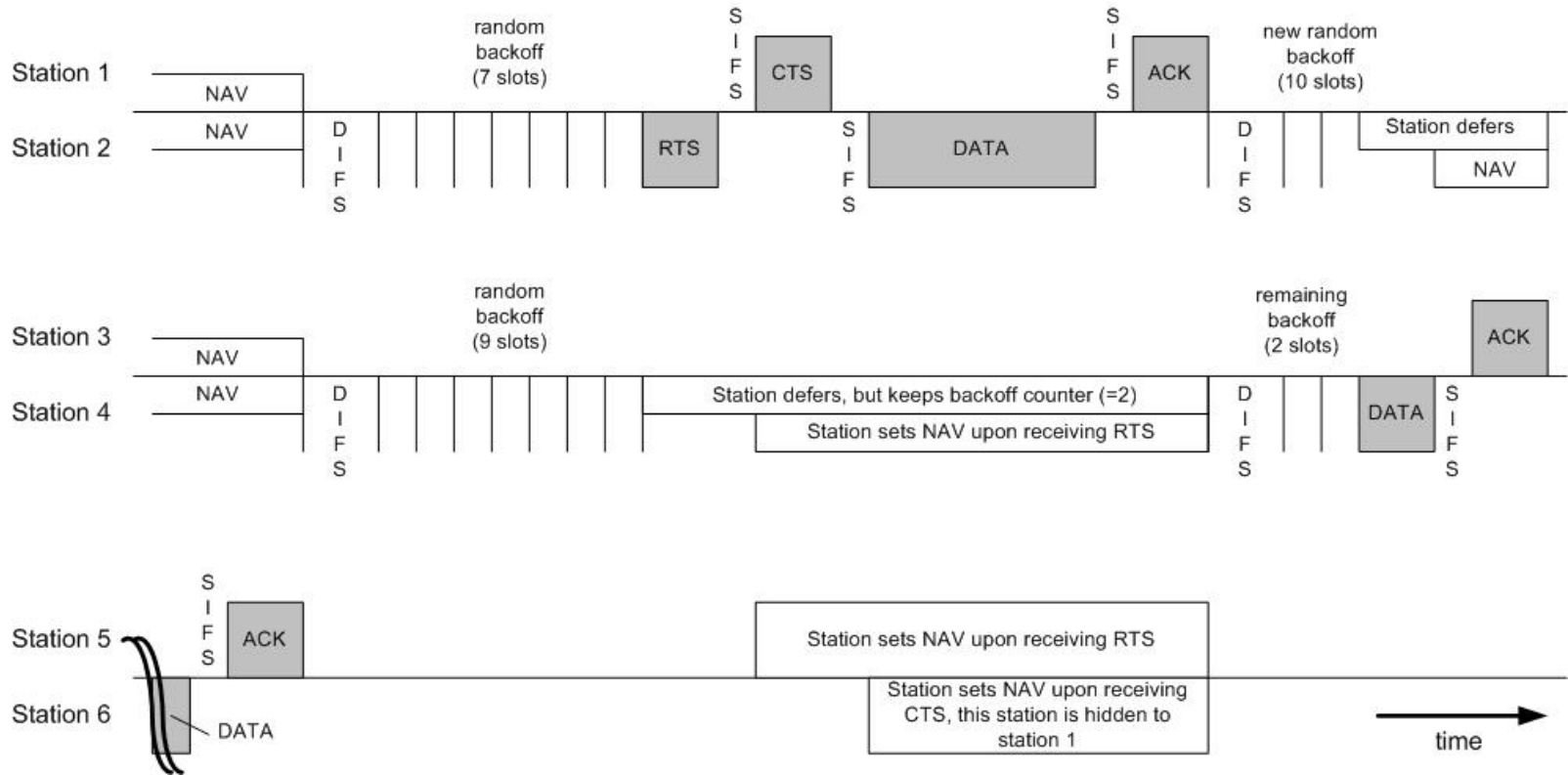
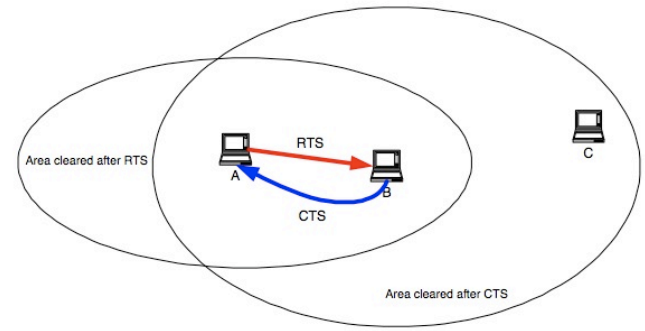

- Single Frequency Network – everyone’s desire
  - It is possible with 802.11 CSMA/CA however quality of service is not guaranteed!!!

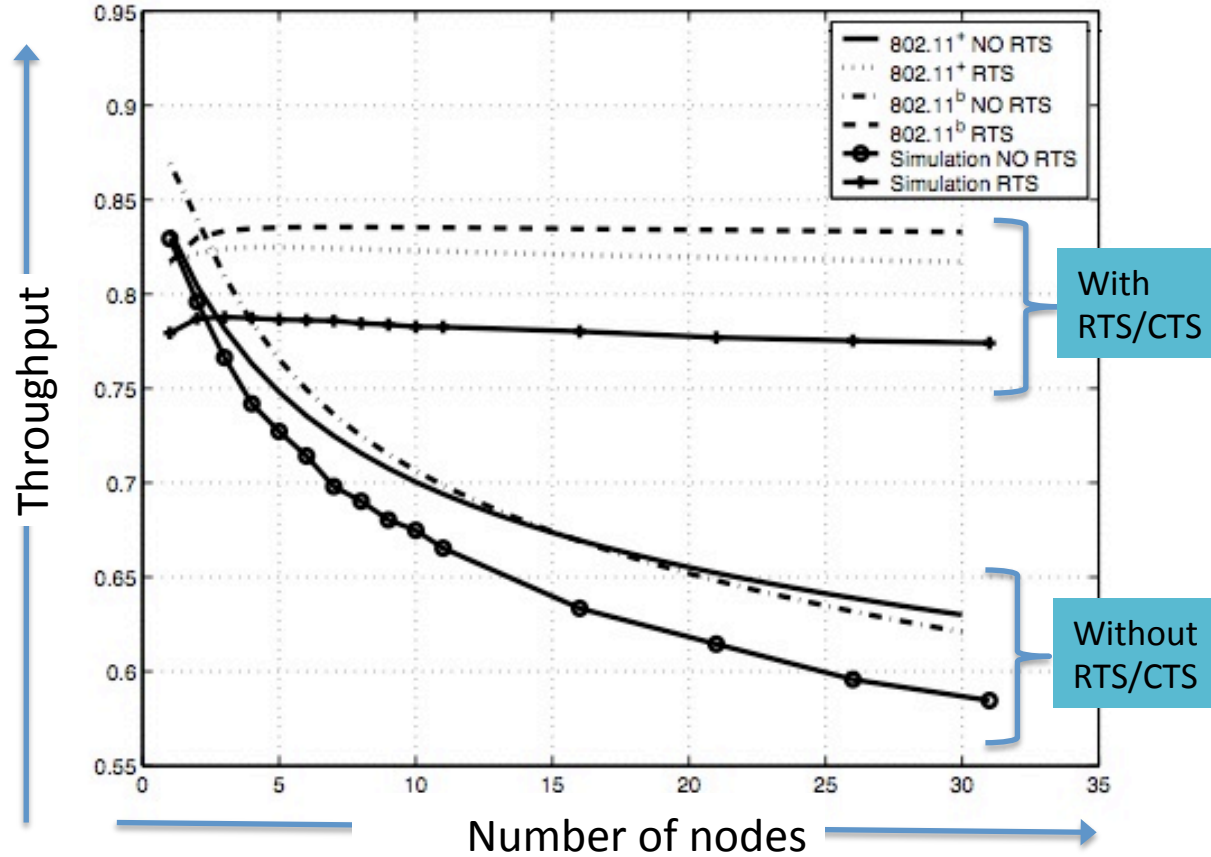

Figure 3.17: Throughput for multi-level backoff

\*I-WLAN, PhD Dissertation, 2004, M. Ergen UC Berkeley





# IEEE 802.11 Family

- IEEE 802.11b
  - Direct spread spectrum at 2.4GHz
  - First standard : 3 channels : 11 Mbps :
- IEEE 802.11a
  - 300Mhz of 5.9GHz only – operates with OFDM
- IEEE 802.11g
  - Operates in 2.4GHz with same design of 802.11a: 54Mbps
- IEEE 802.11e
  - MAC Standard : QoS support
- IEEE 802.11n
  - with MIMO-OFDM: <600Mbps
- IEEE 802.11p
  - DSRC for Vehicular Networks

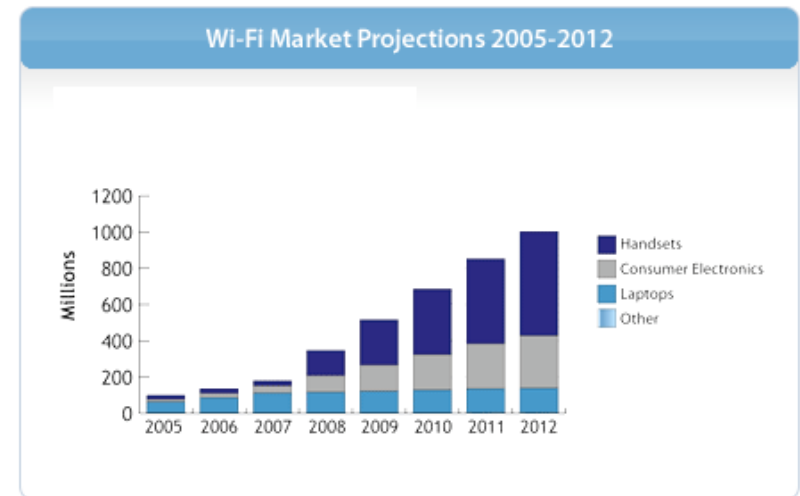



# 3G – Third Generation

- In third generation – two camps aroused
  - However they both adopted **WCDMA** – Wideband CDMA
  - And formed in 1998
- 3GPP: Third Generation Partnership Project
  - [European Telecommunications Standards Institute \(ETSI\)](#) (Europe)
  - [Association of Radio Industries and Businesses/Telecommunication Technology Committee \(ARIB/TTC\)](#) (Japan),
  - [China Communications Standards Association \(CCSA\)](#) (China)
  - [Alliance for Telecommunications Industry Solutions \(ATIS\)](#) (North America)
  - [Telecommunications Technology Association \(TTA\)](#) (South Korea).
- 3GPP2: Third Generation Partnership Project 2
  - ARIB/TTC (Japan)
  - CCSA (China)
  - Telecommunications Industry Association (TIA) (North America)
  - TTA (South Korea)
  - Driven by Qualcomm in USA
- To fulfill the requirements of ITU's IMT-2000



- **International Telecommunication Union** is the eldest organization in the UN family still in existence. It was founded as the *International Telegraph Union* in [Paris](#) on 17 May 1865 and is today the leading United Nations agency for information and communication technology issues, and the global focal point for governments and the private sector in developing networks and services.
  - **ITU-R Radiocommunication**
  - **ITU-T - Standardization**
  - **ITU-D Development**



- **International Mobile Telecommunications-2000 (IMT-2000)** is the global standard for third generation (3G) wireless communications, defined by a set of interdependent ITU Recommendations
- IMT-2000 is particularly a framework that defines the criteria of ubiquitous support. The key criterias are
  - High transmission rates
  - Fixed line voice quality
  - Global roaming and circuit switched services support
  - Multiple simultaneous services
  - Increased capacity and spectral efficiency
  - Symmetric and asymmetric transmission of data

---

UMTS/WCDMA	CDMA Direct Spread
CDMA2000	CDMA Multi-Carrier
UMTS-TDD	Time-Code
TD-SCDMA	Time-Code
UWC-136	Single Carrier
IS-136	Single Carrier
EDGE	Single Carrier
DECT	FDMA/TDMA
WiMAX	OFDMA TDD

---

Another  
multiple  
access scheme  
**OFDMA**



# What is OFDMA?

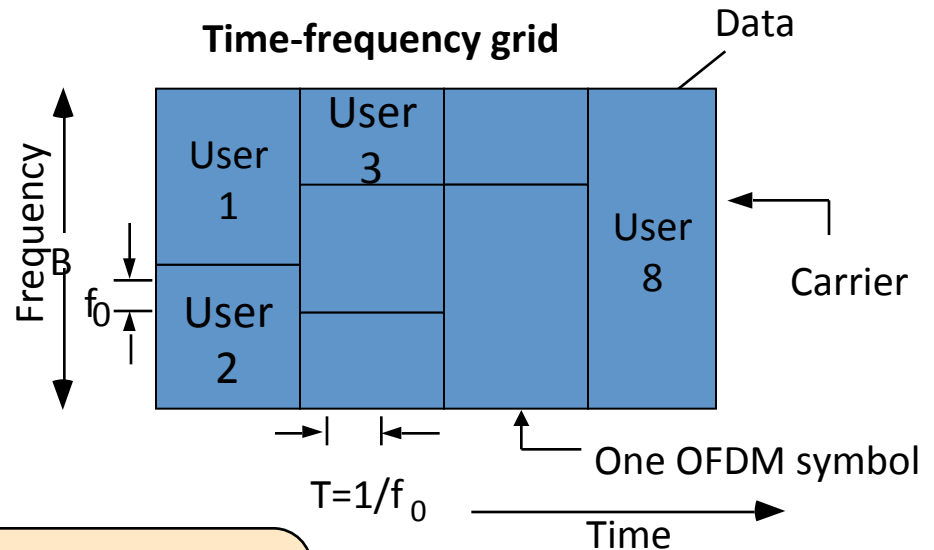
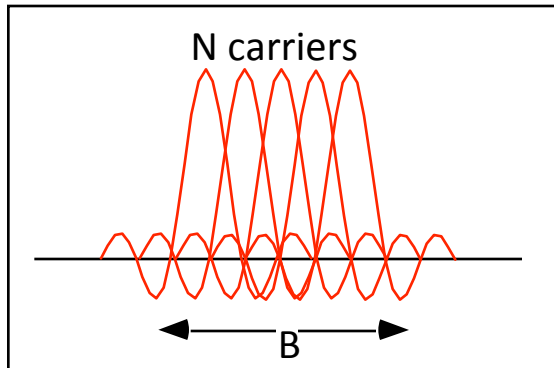

## Features

- No intercarrier guard bands
- Controlled overlapping of bands
- Maximum spectral efficiency (Nyquist rate)
- Easy implementation using IFFTs

Intercarrier Separation =  $1/(\text{symbol duration})$

## Modulation technique

A user utilizes some carriers to transmit its data as coded quantity at each frequency carrier, which can be quadrature-amplitude modulated (QAM).



• UMTS

- NodeB
- SGSN
- GGSN
- MSC
- HLR
- Iu-CS
- Iu-PS
- Iu-b

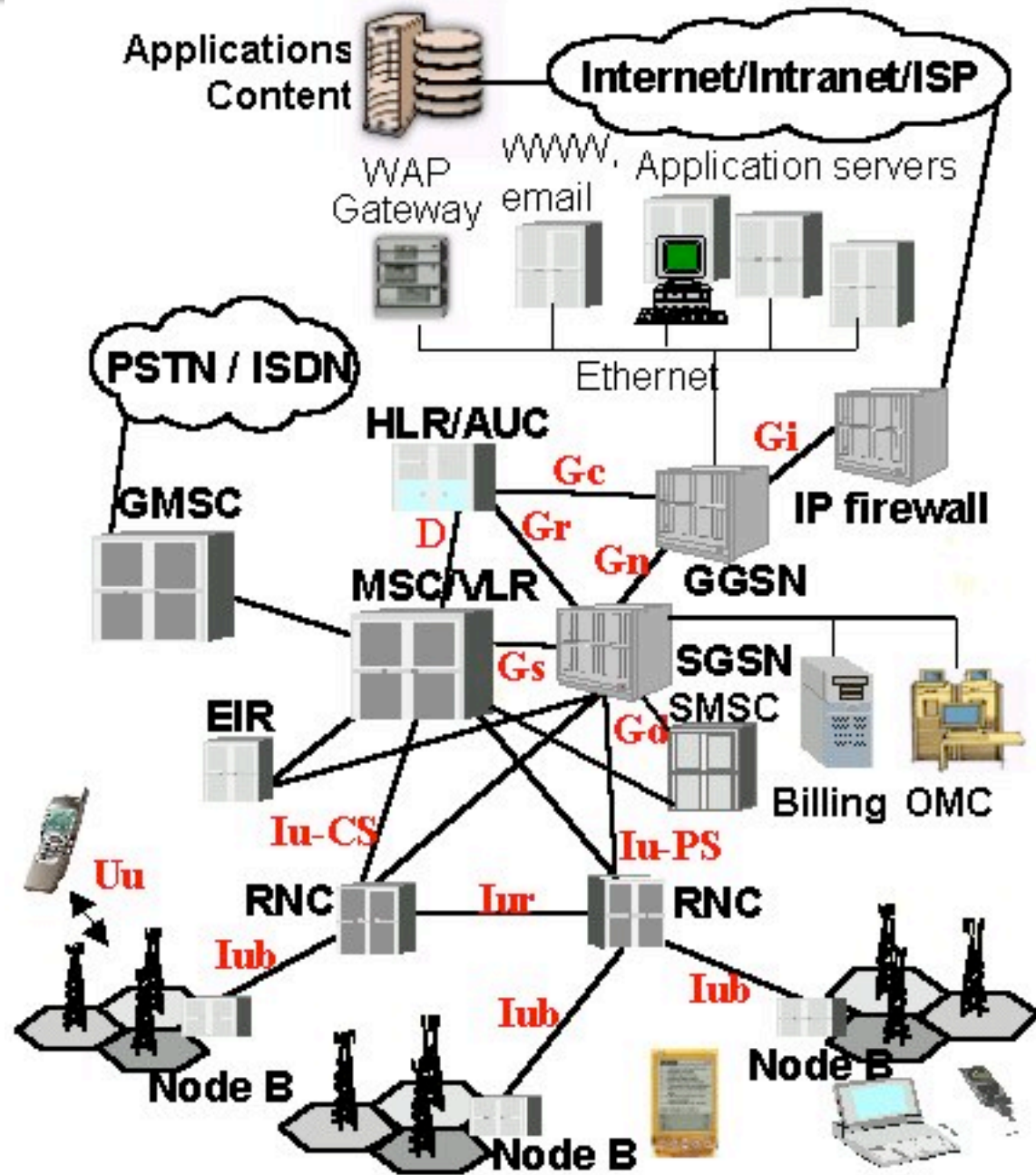



- UMTS: Universal Mobile Telecommunications Systems based on WCDMA
  - After GSM, GPRS and EDGE
  - Rel-99: introduced in 2000
    - 5MHz channel
  - Rel-4: Introduced in 2001
    - Separated the call and bearer network
  - Rel-5: Introduced HSDPA
    - Spectral efficiency with High Speed Downlink Packet Access
    - Introduced IMS – IP Multimedia Subsystem and UTRAN
      - IP UMTS Terrestrial Radio Access Network



- Rel6: introduced in 2005
  - HSUPA: High Speed Uplink Packet Access
  - MBMS: Multimedia Broadcast Multicast Service
    - New term HSPA: HSDPA+HSUPA
    - 16QAM in DL and QPSK in UL
- Rel7: focuses on MIMO and flat-IP
  - GTP tunneling to connect packet switch to radio access network
    - New term HSPA+
    - Interference aware receiver- takes account of interfering cell as well as serving cell
    - 64QAM with MIMO
    - CPC: Continuous Packet Connectivity
      - Keeps more users in the idle mode
    - RNC is integrated to NodeB
    - HSPA+ is missing link between HSPA and LTE
    - Enabler of Femtocell
- Rel8: LTE – Long Term Evaluation – 4G





- CDMA2000

FL: Forward Link - Downlink

RL: Reverse Link - Uplink

- 1x EV-DO Rel 0

- Data-centric delivers up to 2.4Mbps in FL and 153Kbps in RL in a single 1.25MHz FDD – real networks it is around 300-700Kbps in FL and 70-90Kbps in RL
- “Always on” user experience as in IP
- Adaptive Modulation and Coding and Hybrid ARQ

- 1x EV-DO Rev A

- Supports delay sensitive, real-time, and concurrent voice and broadband data applications.
- Utilizes OFDM for multitasking of multimedia
- All-IP based architecture
- 3.1Mbps in FL and 1.8Mbps in RL in 1.25MHz FDD
- Real networks it is around 450-800Kbps in FL and 300-400 Kbps in RL



- **1x EV-DO Rev B**
  - Dynamic bandwidth allocation by aggregating multiple 1.25MHz Rev-A channels
  - Peak data rates scale with the number of carriers aggregated
  - 15 aggregated channels – 46.6Mbps in FL and 27Mbps in RL.
  - 5MHz aggregation – peak data rates is around 14.7Mbps.
  - OFDM based multitasking and introduces lower latency for delay sensitive applications.
- **1x EV-DO Rev C – UMB – Ultra Mobile Broadband – 4G**
  - standard is there but abandoned



- Started with fixed access to compete with DSL and cable modem
  - LMDS- Local Multipoint Distribution Systems
    - Wireless alternative to fiber and coaxial cables in the late 1990s
    - Utilized 28 & 31GHz
    - Several hundreds of megabits per second
    - Roof-top antennas and line-of-sight (LOS)
    - Modified version of DOCSIS
  - MMDS: Multichannel Multipoint Distribution Services
    - 2.5Ghz – become popular in rural areas
    - Modified version of DOCSIS – DOCSIS+
    - Greater range than LMDS but still required LOS



- IEEE 802.16 - Wireless Metropolitan Area Network (Wireless MAN)
  - Begun in 1998 by IEEE
  - Tackled LOS challenge by adopting OFDM
  - WirelessMAN-SC – first standard in 2001
    - Single carrier for operation in 10-66GHz with LOS
  - Wireless MAN-Sca
    - IEEE 802.16a-2003
    - Non-LOS is addressed in 2-11GHz band for licensed and unlicensed spectrum
    - Ratified with 802.16d in 2003 and finalized as 802.16-2004.



- **WirelessMAN-OFDM**
  - NLOS fixed access for 2-11GHz
  - Finalized in 802.16-2004 standard
  - 256 Subcarriers
- **WirelessHUMAN**
  - Similar to OFDM physical layer
  - License exempt bands
- **WirelessMAN-OFDMA**
  - 2048 carriers
  - 802.16e-2005 for mobile access
  - Scalable channel bandwidths from 1.25Mhz to 20Mhz with FFT



- Architecture

IP-Based WiMAX Network Architecture

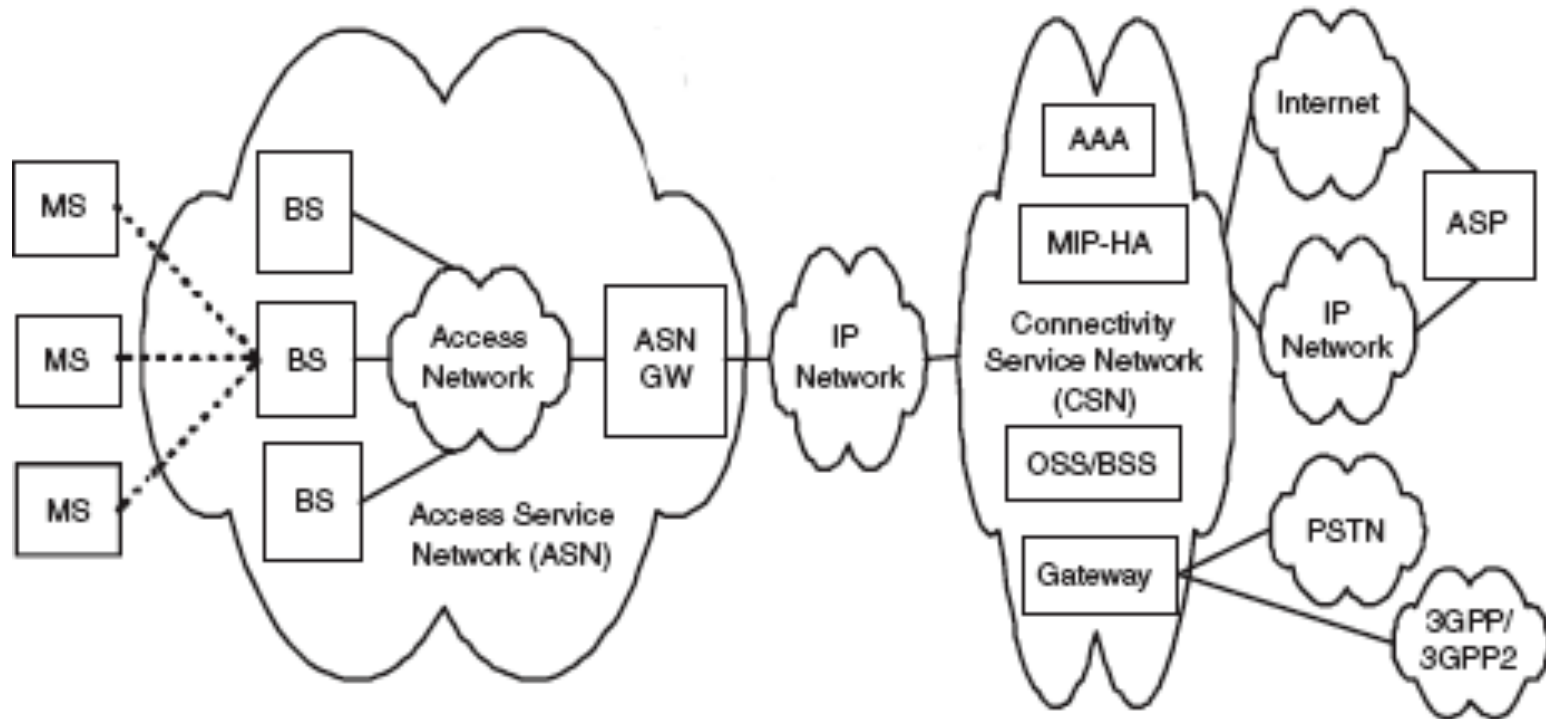



- Adopts OFDMA
  - Faces the challenge of mobility unlike 3G which faces the challenge of data rate.
  - Driven by WiMAX Forum
  - Delivers mobility at Vehicular Speeds
    - Adaptive Modulation and Coding
    - Hybrid ARQ
    - Fast Scheduling
    - Bandwidth efficient handover
    - EV-DO and HSPA are FDD, WiMAX is first TDD now FDD is introduced
    - Operating in 2.5GHz
    - 2x2 MIMO



# KOÇ UNIVERSITY 4G Map

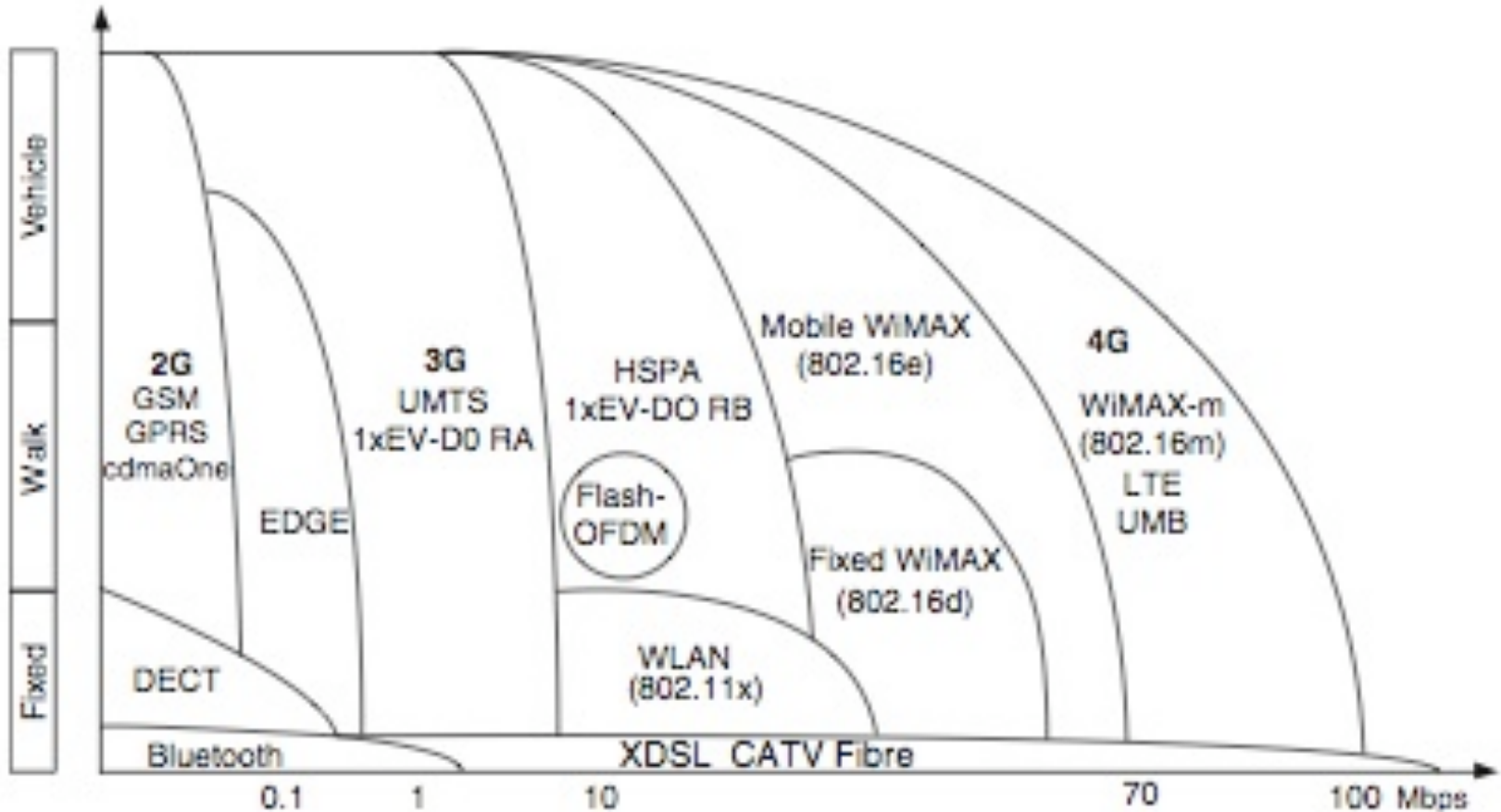





# Modulation Evolution

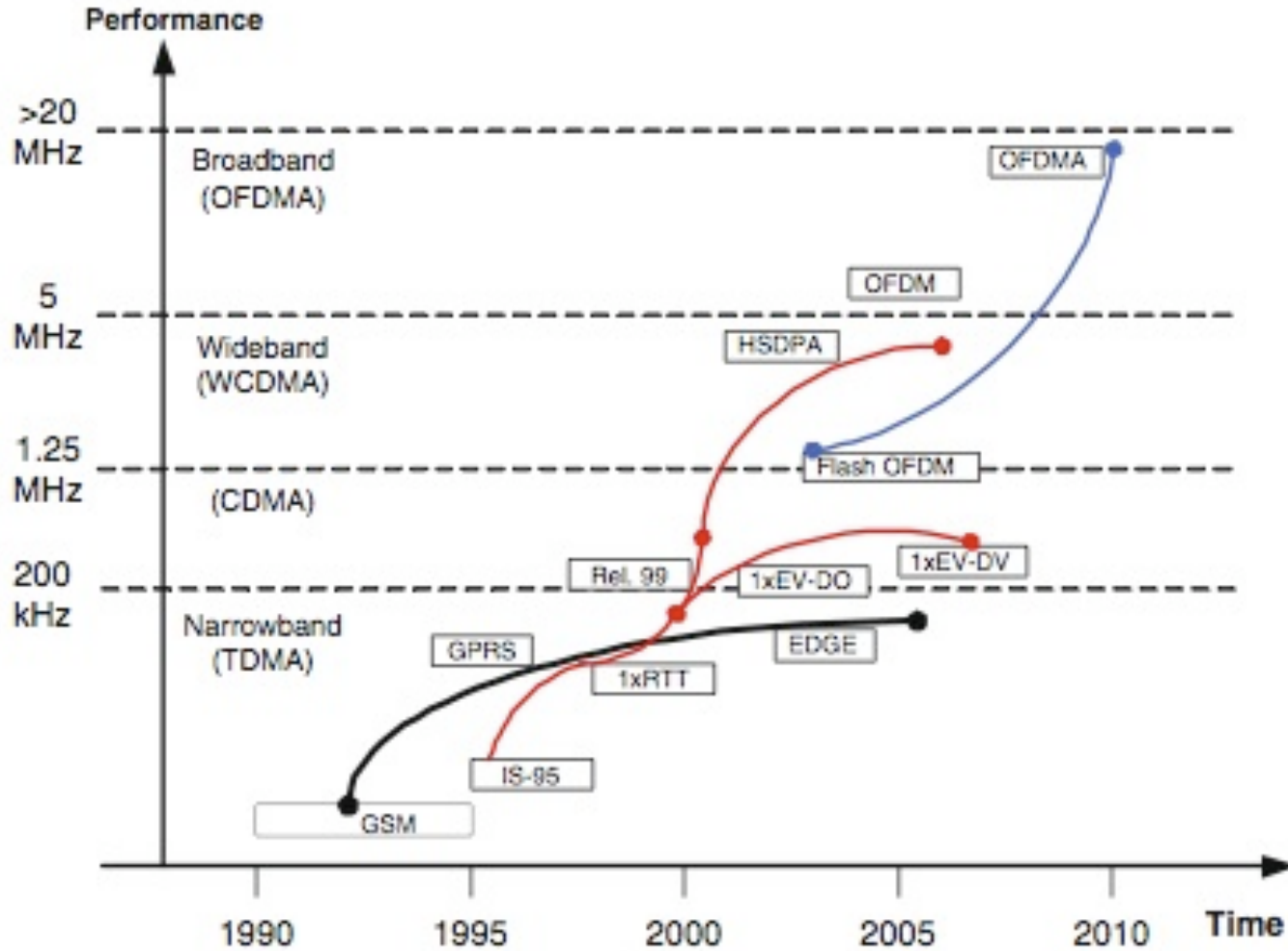

# Convergence towards 4G

Change from WCDMA to OFDMA will be the second significant change after TDMA to WCDMA – WCDMA has restriction to scale the bandwidth...

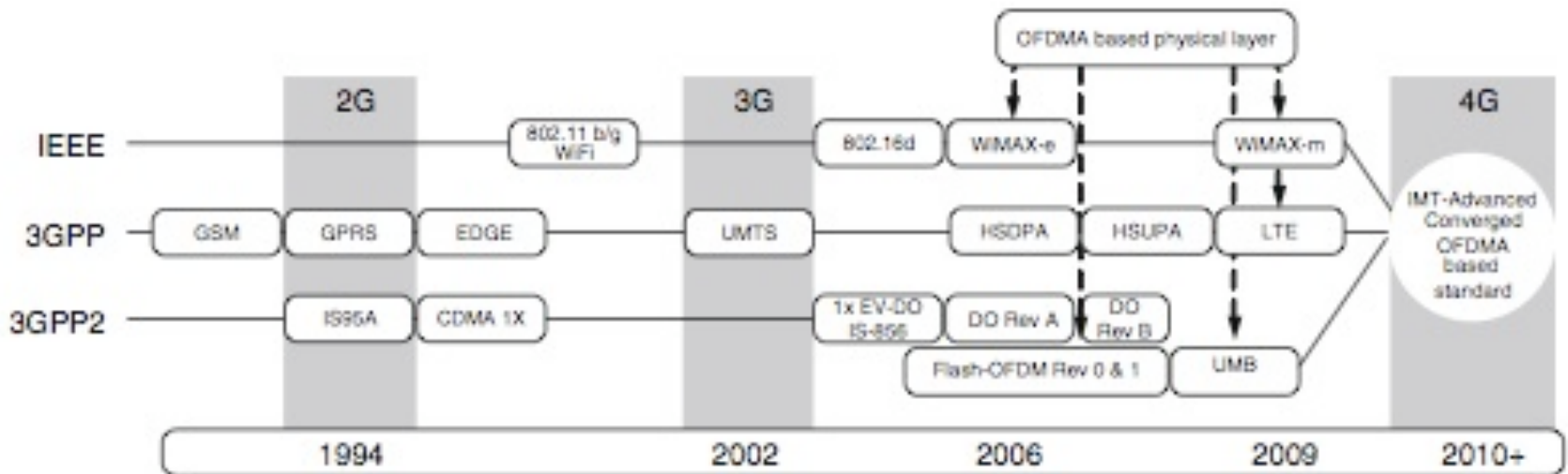



- Defines the standard of 4G
- ITU-R considers data rates up to 100Mbps for high mobility and 1Gbps for low mobility
  - WiMAX-m which is IEEE 802.16m with MIMO
  - LTE with MIMO



- Increased data rates
  - OFDMA, higher modulation, AMC, turbo coding, ARQ, MIMO
- High Spectral Efficiency
  - Reduce cost of per bit
- Flexible radio planning
  - SON: Self-Organizing Network
- Reduced latency
  - Round-trip-times 10ms or less
- All-IP architecture
  - “flat” all-ip based core network



- Interworking
  - Internetworking of existing technologies
- Open Interfaces
  - Multi-vendor network operation
- Spectral flexibility
  - Scalable bandwidths
- Cost reduction capabilities
  - MVNO
- Support for data centric services
  - Revert their declining ARPU



- New technologies are emerging due to the urge of spectral efficiency.
- OFDMA is selected as the air interface of various standards.
- All-IP-based architecture is being adopted for networks .
- Mobile WiMAX and LTE are contending for such an architecture.



- Mobile Broadband, Ergen
- Digital Communications, Rapport
- Wireless Communications, Goldsmith
- IEEE Tutorial, Ergen
- I-WLAN, Ergen